

NOTICE

The purchaser agrees when purchasing this plan (the "Project") to build or construct the object or project set out in the Plan (the "Project") for his/her/its personal use only and not for any other purpose. Any connection of the Plan in whole or in part by any means whatsoever is strictly prohibited.
 3) Blueprints for the Handyman should not be made for any utility plan, as they require a professional to construct the Project or for any loss or damage resulting therefrom.

NOTE: Read all directions before beginning

Directions (4'x8' and 4'x4' sheds)

- Lay out your material on the workbench, as outlined in the suggested materials layout for each component. Draw out cut parts exactly as instructed including the letter designations, all perpendicularly and square. Before cutting, double check all measurements to ensure that they are correct. Always cut on the waste side of the line. Note the 8 degree end cut for pieces A1, A2, A4, A5, A7, A8, C1, C2, C3, C5, C6. To build the 4'x8' shed you will need three components G, two components B, two components F, two components C, two components A, one component D, one component K. To build the 4'x4' shed you will need one component A, B, C, D, F and G. If your building is free standing you will need components E and J. If one side of the shed rests against another structure you can substitute piece H for component E and J.

- Component A (Fig 1). Note A1, A2, A4, A7 and A8 have an 8 degree cut on the top end and A5 is mitered both ends. Mark A1 and A2 77 1/2" up from the bottom of each. Place bottom of A6 at this mark and nail through A1 and A2 into A6 using four 3" common nails, two per side. Nail A3 to A1 with eight 3" common nails keeping the bottoms of A1 and A3 even. Nail A10 into the bottoms of A3 and A1 using two 3" common nails, one per A1 and A3. Nail A5 to A1 and A2 using four 3" common nails, two each, keeping A5 1 1/2" out post A1. Nail A4 to A5 using two 3" common nails through A5 to A4. Nail A9 into bottoms of A2 and A4 using four 3" common nails, two per A2 and A4. Place A7 and A8 between A4 and A6 with the center of A7 and A8 16" from the outside edge of A4 and A6 with the center of A7 and A8 16" from the outside edge of A2 and A4. Nail A7 and A8 into A4 and A6 using eight 3" common nails, two per end of A7 and A8. At this point decide whether you need a right or left hand door for your shed. A-11 is laid out for a right hand door. To make a left hand door simply do layout for A-11 on an inside face of plywood. Cut out A-11. Be sure to cut door opening out on door side of line (care should be taken as this piece forms your door). Nail through A-11 into the door frame, square framing to door opening. Outside edges A4 and A3 should be flush to sides of A-11. A-11 should be 1 1/2" long on top and 4 1/8" longer than framing on bottom. Use forty 2" common nails as follows: six through A-11 into A3, six into A1, six into A4, six into A2, six into A5, six into A6, two into A10, two into A9, and two each into A7 and A8.

- Component B (Fig 2). Place the four pieces B1 between two pieces B2. The center of one of the two center pieces B1 is located 14" from the outside edge of piece B2 and the other is located 16" from the center of this piece B1. Nail this assembly together using sixteen 3" common nails, nailing through the pieces B2 into the ends of the pieces B1, two nails per end. Place B3 on this frame so that piece B3 overlaps the edges of pieces B1 by 2" and overlaps top piece B2 by 1 1/2". Nail piece B3 to the frame using forty 2" common nails six per piece B1 and four per piece B2. 4) Component C6 (Fig 3). Note C1, C2, C3 and C5 have been pre-cut in; Component C6 (Fig 3) Note C1, C2, C3 and C5 are applying plywood to framing note how many components C you need. Components will have to be built as left and right hand nails. Nail through side of piece C4 to piece C1 ensuring that the bottom edges are even. Lay out pieces C1/C4, C2, C3 and C5 as shown see (Fig 3) between pieces C6 and C7. Nail through both ends of pieces C6 and C7 into the ends of the other pieces C that you have laid out, ensuring that pieces C5 and C4 are flush with the outside edges of pieces C6 and C7 and that the center of piece C3 is located 16" from the outside edge of piece C5 and the center of piece C2 is located 16" from the center of piece C1. Use eighteen 3" common nails, two each end of pieces C3, C4, C5 and C6. Nail through C7 into the bottom of pieces C3, C4, C5 and C6 on top of the frame assembly. Nail through the bottom of piece C5 and C6 on top of the frame assembly. Nail through the top edge of piece C8 overhangs the top edge of piece C6 by 1 1/2". Nail piece C8 to the frame using forty 2" common nails, five each, in pieces C6 and C7 and six in each of the other pieces C1, C2, C3, C4 and C5.
- Component D (door) (Fig 4): Place the three pieces D1 between the two pieces D2 as shown and nail with twelve 3" common nails, two per joint. The center piece D1 is 17 5/8" from the outside edge of either of the outside pieces D1. Place piece D3 on this frame, square, and nail to the frame using thirty two 2" common nails.

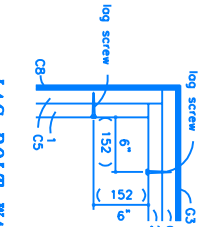

LAG BOLT WALL CONNECTION DETAIL 1

NOTE: Use 1/4"x3" lag bolts to connect walls and floors (Detail 1) if you want the shed to be movable. Place two lag bolts in each side wall, two in each roof connection, two from wall into floor. If you are making the building permanent, level ground at site and set floor on several patio blocks.

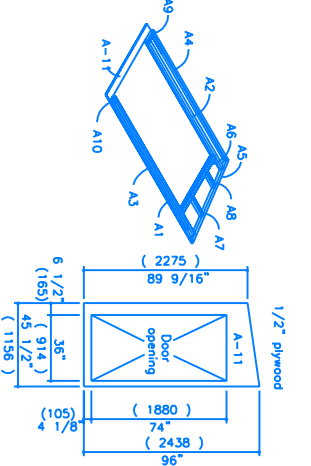

for one end nd cut required E
End cuts are required for pieces A1, A2, A4, A7 & A8.
(Note: dimensions for the plywood pieces are to the long sides)

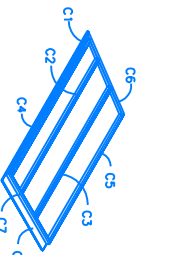
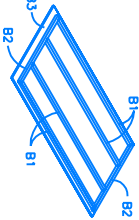

for one end nd cut required E
End cuts are required for pieces C1, C2, C3 & C5.
(Note: dimensions for the plywood pieces are to the long sides)

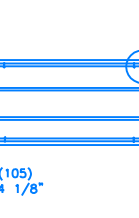
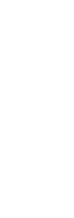
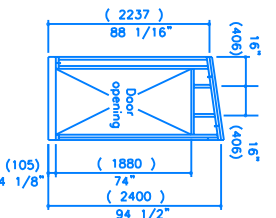
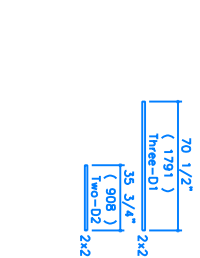
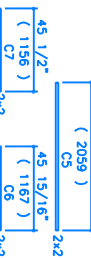
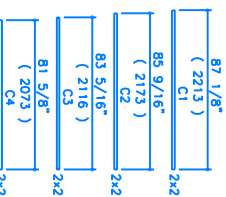
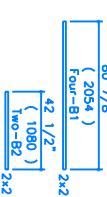
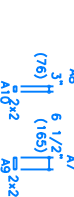
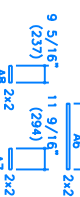
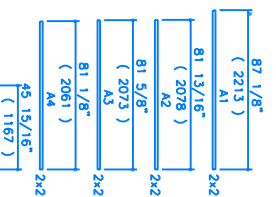
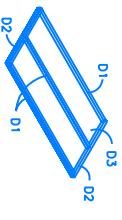

COMPONENT B
FIGURE 2

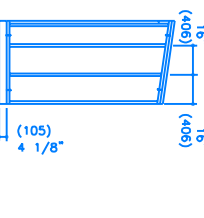

COMPONENT C
FIGURE 3

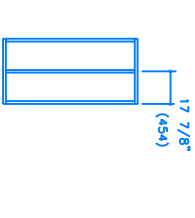

COMPONENT D
FIGURE 4

MATERIALS LIST (8'x4' SHED)

- Sondopex
- Approx. 2 lbs. 3" common nails
- Approx. 2 lbs. 2" common nails
- Approx. 1/2 lb. 3/4" roofing nails
- Door hinges complete with mounting screws
- Door latch kit complete with mounting hardware
- Exterior paint

MATERIALS LIST

- 49 1/2"x4" flashing
- Seven sheets 1/2" plywood
- One sheet 5/8" plywood
- Forty four 8' 2x2 (1 1/2"x1 1/2")
- Six 8' 2x4 (1 1/2"x3 1/2")
- One 8' 2x6 (1 1/2"x3 1/2")
- Forty 3"x3/4" lag bolts (optional)

MATERIALS LIST (4'x4' SHED)

- Sondopex
- Approx. 2 lbs. 3" common nails
- Approx. 2 lbs. 2" common nails
- Door hinges complete with mounting screws
- Door latch kit complete with mounting hardware
- Exterior paint
- Four half sheets 1/2" plywood

MATERIALS LIST

- Half sheet 5/8" plywood
- Twenty nine 8' 2x2 (1 1/2"x1 1/2")
- Three 8' 2x4 (1 1/2"x3 1/2")
- One 8' 2x6 (1 1/2"x3 1/2")
- One 8' 1"x4 (3/4"x3 1/2")
- One 8' 1"x1 (3/4"x3 1/2")
- Twenty four 3"x1/4" lag bolts (optional)

6) Component E (Fig. 5): Note: This component is built for the 4'x4' shed shed wall. Be gong and ready. E is built from one of the four pieces E1 through E4. The center of piece E1 and the other is located 16" from the center of this piece E1. Nail assembly together using sixteen 3" common nails, nailing through the pieces E2 into the ends of the pieces E1, two nails per end. Place E3 on this frame so that piece E3 overlaps the edges of pieces E1 by 2" and overlaps one end of piece E2 by 1 1/2" and 4 1/8" at the bottom. Nail piece E3 to the frame using forty 2" common nails six per piece E1 and five per piece E2.

7) Component F (Fig. 6): Lay out the four pieces F2 between the pieces F1 with 16" between the centers of F2's using sixteen 3" common nails two into each end of pieces F2. Place piece F3 squarely on the F1/F2 assembly. Nail piece F3 to F1/F2 assembly using twenty four 2" common nails, four into each F2 and eight into each F1.

8) Component G (Fig. 7): Note if you are building 4'x4' shed use other half of 5/8" sheet from floor for roof. Layout four pieces G2 between two pieces G1 with 16" between the centers of pieces G2 as shown in (Fig. 7). Nail through pieces G1 into pieces G2 using sixteen 3" common nails, two into each end of pieces G2. Place piece G3 on the top of the pieces G1 and G2. Nail through the pieces G1 and G2 overlapping on the other three edges. Nail to the frame using twenty four 2" common nails.

4'x4' and 4'x8' shed assemblies

Note: A helper will be required for assembly.

4'x8' shed assembly

To build the 4'x8' shed refer to figure 8. From the underside nail or bolt two floor components F together using eight 3" common nails or three 3 1/4" lag bolts. Turn F assembly over with a helper set. Bolt C on floor F, nail C to F through C7 with two 3" common nails. Be sure the 4 1/8" overlap of C covers side of F. Next place a wall B adjacent to C. Nail B to F. Next place A on end of B. Nail bottom plates of A to F and nail inside corner of B to ends of walls A and C. Use three 3" common nails into each wall. Looking from the outside, B should be flush with the ends of walls A and C. Use eight 3" common nails into beam pocket in A and C with eight 3" common nails. Nailing one piece H to beam pockets in A and C with two nails each end. Nail second piece H to first H with four 3" common nails. Stand other two walls C on ends of standing walls A and C. Nail top edges of C through beam pocket into H with two 3" common nails either side. Nail bottom plates of C to F. Using a scrap piece of plywood, nail across studs between C and C walls and A and C walls to reinforce wall joint. Stand last wall B in place and attach in a similar fashion to first wall B. Place two roof sections G in place with plywood over the walls. Nail each G down to wall plates and H with eight 3" common nails, two each side of G. Nail for nail heads and finish each with two 2" common nails or G1 nail if you prefer. If you prefer, you will need to flush roof with K nail K to G3 with 3/4" roofing nails, six each side. Hang door D in A, you may have to plane a bevel in back edge of door so it will close evenly. Screw hinges to outside of door so door opens outwards, attach your door latch (according to manufacturer's instructions). Use a plywood trimming for doorstop on the inside of shed, nailing it to A2 with six 2" common nails. Add decorative trim if desired and paint with exterior paint.

4'x4' Shed Assembly

To build the 4'x4 shed refer to figure 9. With a helper set wall C on floor F, nail C to F through C7 with two 3" common nails. Be sure the 4 1/8" overlap of C covers side of F. Next place a wall B adjacent to C. Nail B to F. Attach A on end of CB assembly. Nail bottom plates of A to F and nail inside corner studs of B to ends of walls A and C. Use three 3" common nails into each wall. Looking from the outside, B should cover ends of walls A and C forming a finished corner. Place roof G in place with plywood overhanging walls ABC. If shed is free standing, place wall E in place. Nail E to F then to ends of AC. Nail G from the top into tops of ABC using eight 3" common nails. Nail heads and finish roof either with shingles, roofing tar or point. Nail component J to high side of roof with four 2" common nails. J acts as a ridge cap and is nailed to the roof with four 2" common nails. If you are building substitute piece H for wall E and use flashing against existing building to replace J. Hang door D in A, you may have to plane a bevel in back edge of door so it will close easily. Screw hinges to outside of door so door opens outwards, attach your door latch (according to manufacturer's instructions). Use a plywood trimming for doorstop on the inside of shed, nailing it to A2 with six 2" common nails. Add decorative trim if desired and paint with exterior paint.

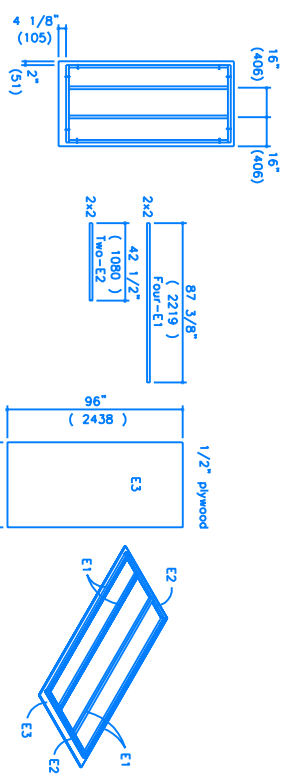

COMPONENT E

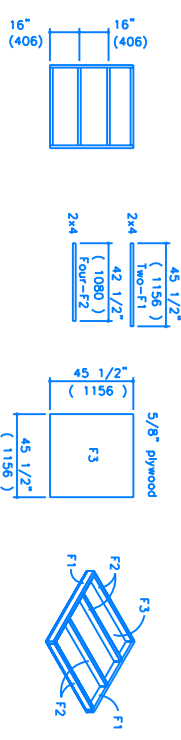

COMPONENT F

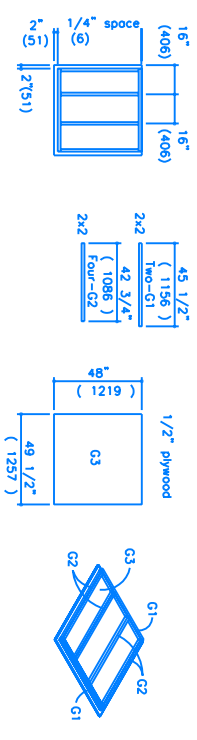

COMPONENT G

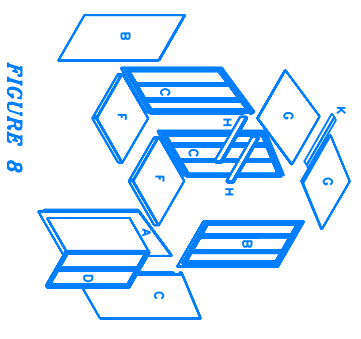

FIGURE 8

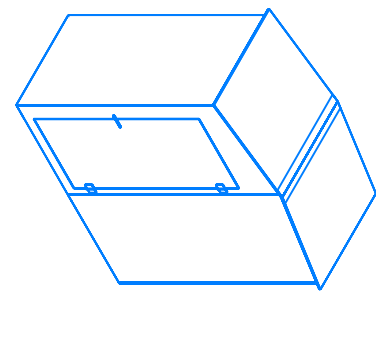
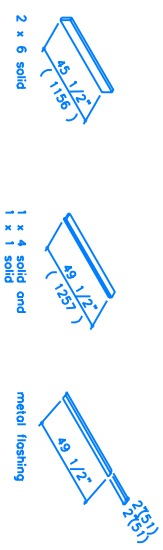
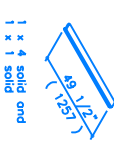

FIGURE 9



COMPONENT H



COMPONENT J

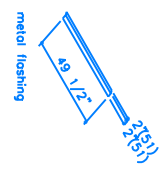

COMPONENT K

- TOOLS**
- Table Saw and Jigsaw
 - Panel and Measuring Tape
 - Power Drill
 - 1 1/16" 1/8" 1/4" 3/8" drill bits
 - Hammer and Screwdrivers
 - Square and Nail Set
 - Plane and Wood Chisels
 - Paint Brush and Putty Knife